

Magic series MPPT Solar Controller

12/24/48V, 10/15/20/30/40A,
130/200/260/390/520/780W,
1KW/2KW

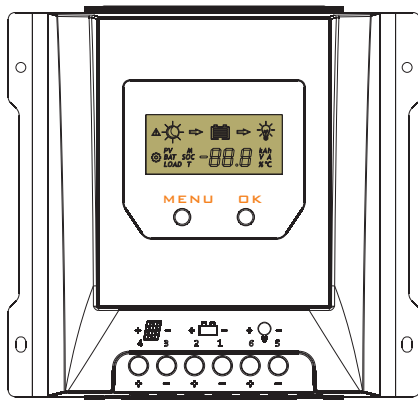

User Manual

User Manual_Magic series_MF
CE, Rohs, ISO9001:2015
Subject to change without notice!

Contents

1.Safety instructions and waiver of liability	2
1.1 Safety Instructions.....	2
1.2 Liability Exclusion.....	2
2.Product Overview	3
3.Dimensions	4
3.1 The dimensions of MT1050/1550-EU/MT1050-RS485	4
3.2 The dimensions of MT2075/2010/3075.....	5
3.3 The dimensions of MT3010/4010.....	6
3.4 The dimensions of MT4015	7
4.Structure & Accessory	8
4.1 Structure & Characteristics of MT1050/1550-EU/MT1050-RS485	8
4.2 Structure & Characteristics of MT2075/2010/3075.....	8
4.3 Structure & Characteristics of MT3010/4010/4015.....	9
4.4 Temperature Sensor	9
4.5 RS485	10
4.6 Optional Accessories.....	10
5.Installation	12
5.1 Installation Notes.....	12
5.2 Mounting Location Requirements.....	12
5.3 Wiring Specifications	13
5.4 Connection	13
5.5 Grounding.....	14
6.Operation	15
6.1 LCD Display.....	15
6.2 Key function	17
6.3 USB interface	17
6.4 Parameters setting.....	18
7.Protections, Troubleshooting and Maintenance	20
7.1 Troubleshooting	20
7.2 Protection.....	21
7.3 Maintenance	21
8.Technical Data	22

Dear Clients,

Thank you for purchasing our Magic Series Solar PV Charge Controller. Your support and trust in us are much appreciated. Please take time to read this manual, this will help you make full use of the many advantages this controller can provide your PV-System with. This manual presents important recommendations for installing, operating and monitoring. Read it with special care in your own interest and please pay attention to the safety recommendations herein indicated.

1, Safety instructions and waiver of liability

1.1 Safety Instructions

The following symbols are used throughout this manual to indicate potentially dangerous conditions or mark important safety instructions. Please take care when meeting these symbols.



WARNING: Indicates a potentially dangerous condition. Use extreme caution when performing this task.



CAUTION: Indicates a critical procedure for safe and proper operation of the controller.



CAUTION:

- 1) There are no user serviceable parts inside the controller. Do not disassemble or attempt to repair the controller.
- 2) Keep children away from batteries and the charge controller.

1.2 Liability Exclusion

The manufacturer shall not be liable for damages, especially on the battery, caused by use other than as intended or as mentioned in this manual or if the recommendations of the battery manufacturer are neglected. The manufacturer shall not be liable if there has been service or repair carried out by any unauthorized person, unusual use, wrong installation, or bad system design.

2, Overview

Magic series solar controller is based on an advanced maximum power point tracking (MPPT) technology developed, dedicated to the solar system, the controller conversion efficiency up to 98%.

It comes with a number of outstanding features, such as:

- A combination of multiple tracking algorithms enables tracking the maximum power point quickly and accurately
- Innovative Max Power Point Tracking(MPPT) technology, tracking efficiency >99.9%
- Full digital technology, high charge conversion efficiency up to 98%
- LCD display design, read operating data and working condition easily
- Real-time energy statistics function
- 12/24/48V automatic recognition
- Flexible System battery selection: Liquid, Gel, AGM and Lithium
- Extends battery life through accurate remote temperature sensor
- The Controller is protected against over-temperature due to built-in power reduction function
- Four stages battery charging process: MPPT, boost, equalization, float
- Dual automatic protection to avoid exceeding the rated charging power and current
- Multiple load control modes: Always on, Street lamp, User-defind Mode
- Two USB interfaces(only -EU model)
- IOT Wireless communication or Bluetooth communication functions optional
- With the wireless communication function of the IOT , the controller can be connected remotely through IoT/GPRS
- Monthly charging data can be calculated and displayed by grouping and graphs
- Based RS-485 standard Modbus protocol with RJ11 interface to maximize the communication needs of different occasions.
- Perfect EMC & thermal design
- Full automatic electronic protect function for increased charge controller availability

2.2 MPPT

MPPT profile

The full name of the MPPT is maximum power point tracking. It is an advanced charging way which could detect the real-time power of the solar Module and the maximum point of the I-V curve that makes the highest battery charging efficiency.

Current Boost

Under most conditions, MPPT technology will "boost" the solar charge current.

MPPT Charging: Power Into the controller (**Pmax**)=Power out of the controller (**Pout**)

$$I_{in} \times V_{mp} = I_{out} \times V_{out}$$

* Assuming 100% efficiency. Actually, the losses in wiring and conversion exist.

If the solar module's maximum power voltage (V_{mp}) is greater than the battery voltage, it follows that the battery current must be proportionally greater than the solar input current so that input and output power are balanced. The greater the difference between the V_{mp} and battery voltage, the greater the current boost. Current boost can be substantial in systems where the solar array is of a higher nominal voltage than the battery as described in the next section.

High Voltage Strings and Grid-Tie Modules

Another benefit of MPPT technology is the ability to charge batteries with solar arrays of higher nominal voltages. For example, a 12 Volt battery bank may be charged with a 12-, 24-, 36-, or 48-Volt nominal off-grid solar array. Grid-tie solar modules may also be used as long as the solar array open circuit voltage (V_{oc}) rating will not exceed the maximum input voltage rating at the worst-case (coldest) module temperature. The solar module documentation should provide V_{oc} vs. temperature data.

Higher solar input voltage results in lower solar input current for a given input power. High voltage solar input strings allow for smaller gauge solar wiring. This is especially helpful and economical for systems with long wiring runs between the controller and the solar array.

An Advantage Over Traditional Controllers

Traditional PWM controllers connect the solar module directly to the battery when recharging. This requires that the solar module operates in a voltage range that is usually below the module's V_{mp} . In a 12 Volt system for example, the battery voltage may range from 10.8-15 Vdc, but the module's V_{mp} is typically around 16 or 17V.

Because traditional controllers do not always operate at the V_{mp} of the solar array, energy is wasted that could otherwise be used to charge the battery and power system loads. The greater the difference between battery voltage and the V_{mp} of the module, the more energy is wasted.

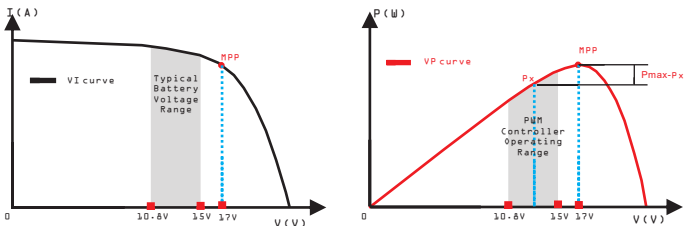

Nominal 12 Volt Solar Module I-V curve and output power graph.

In contrast with the traditional PWM controller, MPPT controller could play a maximum power of the solar panel so that a larger charging current could be supplied. Generally speaking, the MPPT controller's energy utilization efficiency is 15%~20% higher than PWM controller.

Conditions That Limit the Effectiveness of MPPT

The V_{mp} of a solar module decreases as the temperature of the module increases. In very hot weather, the V_{mp} may be close to or even less than the battery voltage. In this situation, there will be very little or no MPPT gain compared to traditional controllers. However, systems with modules of higher nominal voltage than the battery bank will always have an array V_{mp} greater than the battery voltage. Additionally, the savings in wiring due to the reduced solar current make MPPT worthwhile even in hot climates.

2.3 MPPT—Four Charging Stages

Magic series controller has a 4-stage battery charging algorithm for rapid, efficient, and safe battery charging.

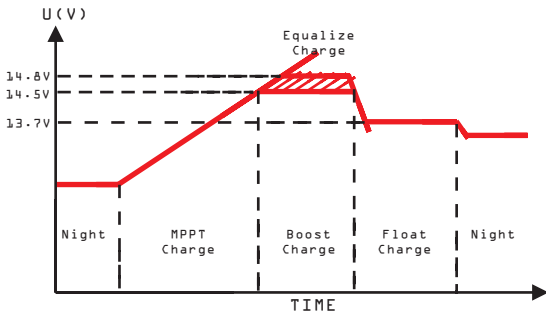

MPPT Charge

In this stage, the battery voltage has not yet reached boost voltage and 100% of available solar power is used to recharge the battery.

Boost Charge

When the battery has recharged to the Boost voltage setpoint, constant-voltage regulation is used to prevent heating and excessive battery gassing. The Boost stage remains 120 minutes and then goes to Float Charge. Whenever the controller is powered on, if it detects neither over discharged nor overvoltage, the charging will enter into the boost charging stage.

Float Charge

After the Boost voltage stage, the controller will reduce the battery voltage to Float voltage setpoint. When the battery is fully recharged, there will be no more chemical reactions and all the charge current transmits into heat and gas at this time. Then the controller reduces the voltage to the floating stage, charging with a smaller voltage and current. It will reduce the temperature of the battery and prevent the gassing, also charging the battery slightly at the same time. The purpose of Float stage is to offset the power consumption caused by self consumption and small loads in the whole system, while maintaining full battery storage capacity.

In the Float stage, loads can continue to draw power from the battery. If the system load(s) exceed the solar charge current, the controller will no longer be able to maintain the battery at the Float setpoint. Should the battery voltage remains below the boost reconnect charging voltage, the controller will exit the Float stage and return to Bulk charging.

Equalize Charge

Certain types of batteries benefit from periodic equalizing charge, which can stir the electrolyte, balance battery voltage and complete chemical reaction. Equalizing charge increases the battery voltage, higher than the standard complement voltage, which gasifies the battery electrolyte. If it detects that the battery is being over discharged, the solar controller will automatically turn the battery to the equalization charging stage, and the equalization charging will be 120mins. Equalizing charge and boost charge are not carried out constantly in a full charge process to avoid too much gas precipitation or overheating of the battery.



WARNING: Risk of explosion!

Equalizing flooded battery can produce explosive gases, so well ventilation of battery box is necessary.

3, Dimensions

3.1 The dimensions of MT1050/1550-EU/MT1050-RS485

Unit:mm

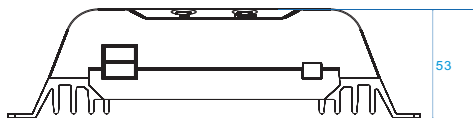

MT1050/1550-EU

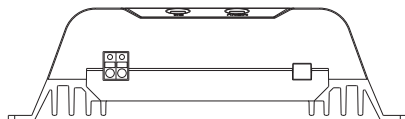
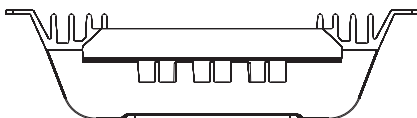
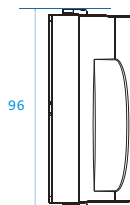
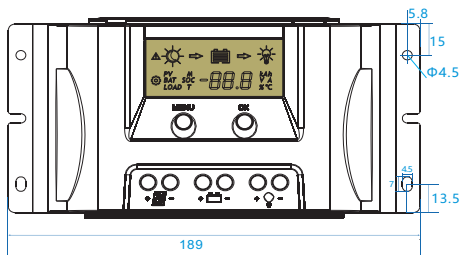

MT1050-RS485

3.2 The dimensions of MT2075/2010/3075

Unit:mm

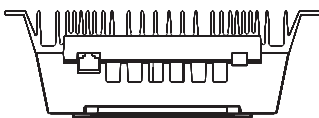
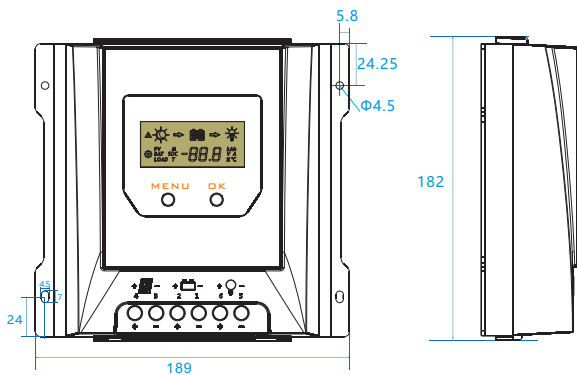
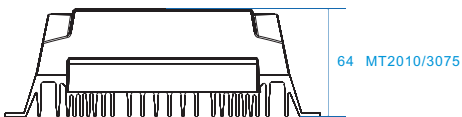
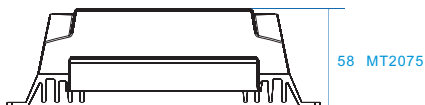

3.3 The dimensions of MT3010/4010

Unit:mm

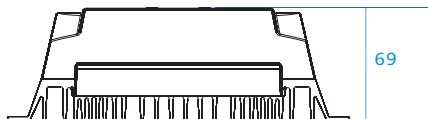

MT4010

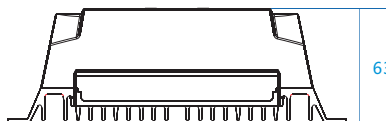

MT3010

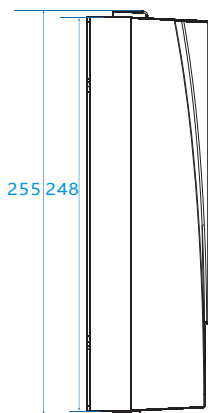
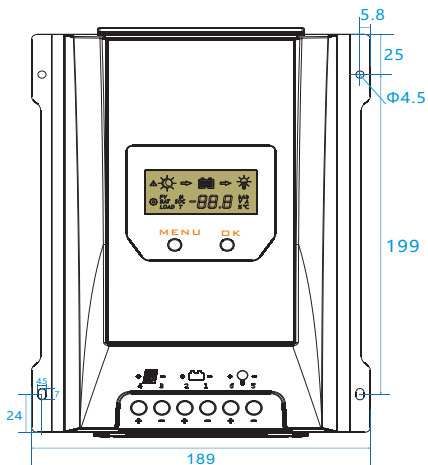

255 248

199

189

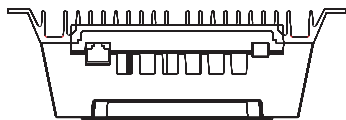

MT3010

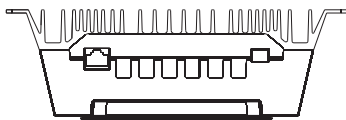

MT4010

3.4 The dimensions of MT4015

Unit:mm

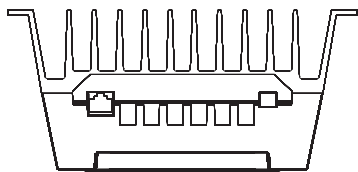
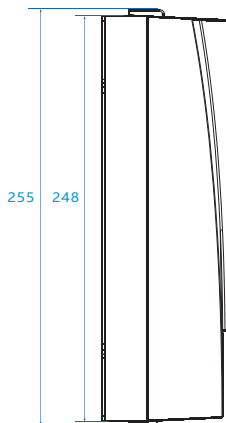
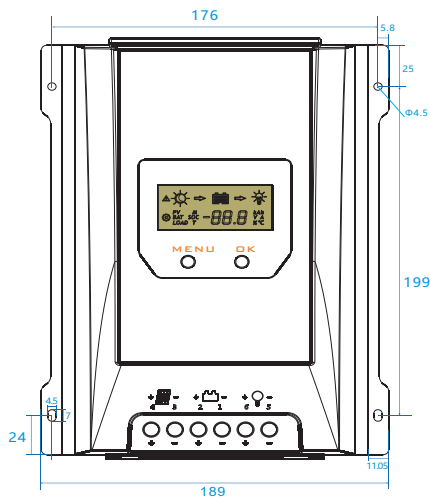
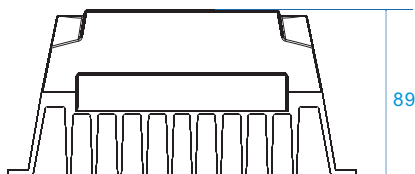

4, Structure & Accessory

4.1 Structure & Characteristics of MT1050/1550-EU/MT1050-RS485

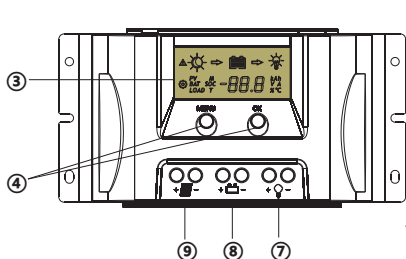

- ① Heat Sink
—dissipate controller heat
- ② Plastic Case
—Internal protection
- ③ LCD
—Display settings and operating status, system parameters
- ④ Key: MENU, OK
—Set and view the operating parameters
- ⑤ Temperature Sensor Port
—Collect temperature information, Temperature compensation.
- ⑥ Two USB interfaces
—Output 5V, 2A
- ⑦ Load Terminals
—Connected load.
- ⑧ Battery Terminals
—Connect the battery.
- ⑨ Solar module terminals
—Connected solar modules.
- ⑩ RS485 communication interface
—Connecting monitoring devices

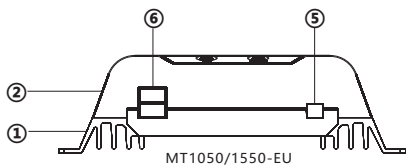

MT1050/1550-EU

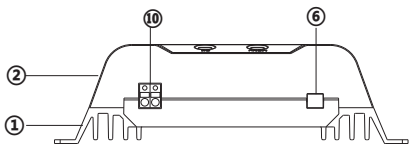

MT1050-RS485

4.2 Structure & Characteristics of MT2075/2010/3075

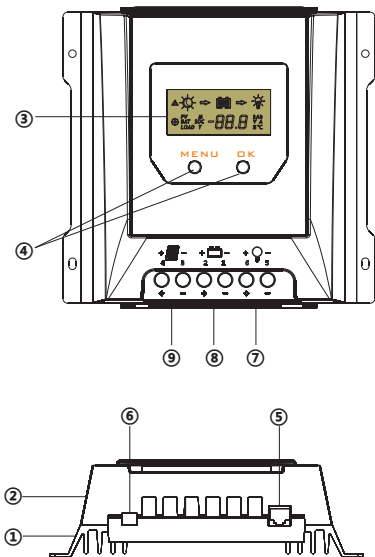

- ①Heat Sink
—dissipate controller heat
- ②Plastic Case
—Internal protection
- ③LCD
— Display settings and operating status, system parameters
- ④Key: MENU、OK
—Set and view the operating parameters
- ⑤RJ11 interface
—Connecting monitoring devices
- ⑥Temperature Sensor Port
—Collect temperature information, Temperature compensation.
- ⑦ Load Terminals
—Connected load.
- ⑧Battery Terminals
—Connect the battery.
- ⑨Solar module terminals
—Connected solar modules.

4.3 Structure & Characteristics of MT3010/4010/4015

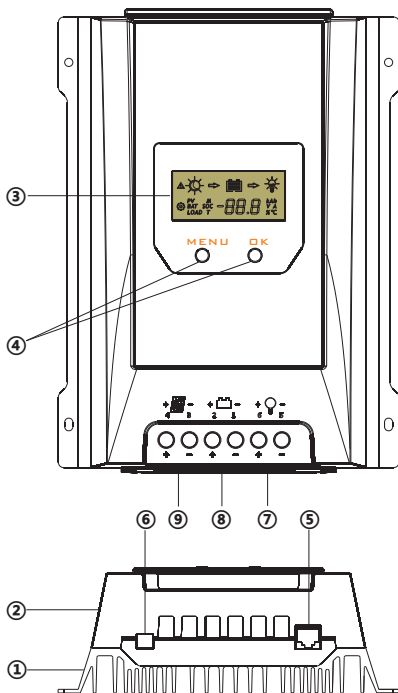

- ① Heat Sink
—dissipate controller heat
- ② Plastic Case
—Internal protection
- ③ LCD
— Display settings and operating status, system parameters
- ④ Key: MENU、OK
—Set and view the operating parameters
- ⑤ RJ11 interface
—Connecting monitoring devices
- ⑥ Temperature Sensor Port
—Collect temperature information, the Temperature compensation.
- ⑦ Load Terminals
—Connected load.
- ⑧ Battery Terminals
—Connect the battery.
- ⑨ Solar module terminals
—Connected solar modules.

4.4 Temperature Sensor

To collect battery temperature data for temperature compensation so the controller can accurately charge the battery. The temperature sensor is connected via interface 6.

If the remote temperature sensor is not connected to the controller or damaged, the default temperature for battery charging is 25 °C .

The controller is shipped with an 80 mm long cable temperature sensor. Should a sensor with a longer cable be required than this needs to be ordered separately.

4.5 Rs485

MT1050-RS485 refer to figure 1 for interface

RS485 port with RJ11 interface controller. The interface definition is shown in Figure 2:

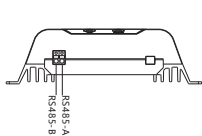
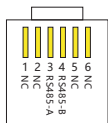



figure 1



RJ11 for controller

figure 2

Pin No.	Definition
1	NC
2	NC
3	RS485-A
4	RS485-B
5	NC
6	NC

 Please contact the sales for the latest version of the communication protocol.



The RS485 interface on this charger is not galvanically isolated and can not be grounded. Do not short circuit unused pin (Note NC).

4.6 Option Accessories

4.6.1 Bluetooth Communication

Two options are available:

1. BT inside
2. BT external (Cyber-BT), and connected via RJ11 connector.

Bluetooth communication has the following characteristics :

1. Support mobile phone App
2. Realizes wireless monitoring function of PV charge controller
3. Use high performance, ultra-low power consumption Bluetooth dedicated chip
4. Adopt Bluetooth 5.0 and BLE technology
5. Communication distance up to 10m.



1. This icon in this specification indicates that this solar controller has Bluetooth communication function.

2. Refer to Bluetooth APP instructions for detailed operation of mobile APP.

4.6.2 Wireless Communication for Internet of Things

The controller equipped with the Internet of Things wireless communication capability has the following characteristics:

1. For the wireless Internet of Things communication functionality the controller can be remotely accessed through IOT/GPRS.
2. A variety of options are available for remote monitoring and real-time control through WeChat App /PC program.
3. Real-time monitoring of PV voltage, PV charging current, battery voltage, battery current, load voltage, load current and other system parameters as well as charge controller status.
4. Real-time automatic fault alarm.
5. Charging and discharging quantities can be counted and displayed by item grouping and month.

 **IoT Please contact our Sales Team for more details about the IoT wireless communication.**

5, Installation



CAUTION: Please read all instructions and precautions in the manual before proceeding with the installation! It is recommended to remove the protective film cover from the LCD screen before operation.

5.1 Installation Notes

- (1) This charge controller must only be used in PV systems by requirements given in this user manual and the specifications of other system components provided by their manufacturers. No energy source other than a PV generator may be connected to the PV charge controller referred to herein.
- (2) PV-modules must always be disconnected prior to the installation and adjustments of the charge controller; Make sure the circuit breaker, fuse or disconnects of the battery terminal are turned off.
- (3) Double check whether battery voltage meets the voltage range of the Charge Controller.
- (4) Batteries store a large amount of energy, never short circuit a battery under any circumstances. We strongly recommend connecting a protection fuse directly to the battery terminal for protection in case of short circuiting the battery.
- (5) Batteries can produce flammable gases. Avoid provoking any sparks, using fire or any exposed flame close to any batteries, ever. Make sure that the battery room is well ventilated to disperse any gases.
- (6) Only use insulated tools and avoid placing (any) metal objects near/close to batteries.
- (7) Be extremely cautious when working with batteries. Wear eye protection by all means. Have fresh water available to immediately wash and clean any contact with battery acid. Get immediate medical aid in case of any hazard that may occur. Never install/handle with batteries alone.
- (8) Avoid touching or short-circuiting wires or terminals. Be aware that voltages on given system components, terminals or wires can be a multiple of battery voltage. Only use insulated tools, stand on dry ground, and keep your hands always dry and protected by proper (approved) electrician gloves when working on PV-Systems.
- (9) Prevent any water, ever, from penetrating the controller, outdoor installation must avoid any direct sunlight and penetration of any water (e.g. rain) and humidity.
- (10) After installation make sure that all connections are properly tightened, and eliminate any electrical loose connections to eliminate by all means any hot electrical connection spots.

5.2 Mounting Location Requirements

Do not subject the PV charge controller to direct sunlight or any other heat sources. Protect the PV charge controller from any dust, dirt and moisture. Mount it flat to a vertical wall. Must be a non-flammable material. Maintain a minimum clearance of 15 cm below and around the controller to ensure unhindered air circulation. Mount the PV charge controller not too far from the batteries (for accurate voltage sensing least lessening).

Mark the position of the PV charge controller fastening holes on the wall, drill 4 holes and insert dowels, fasten the PV charge controller to the wall with the cable openings facing downwards.

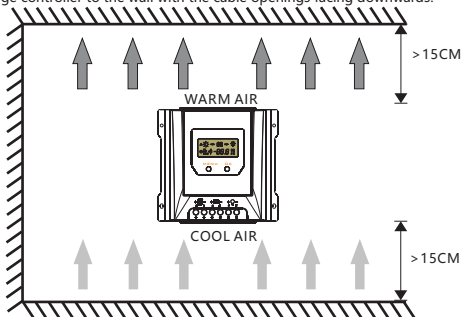

5.3 Wiring Specifications

Wiring and installation methods must comply with national and local electrical codes/specifications.

The wiring specifications of the PV system battery must be selected according to rated currents. Please check following table for wiring specifications:

Model	Rated charging current	Rated discharging current	Solar wire diameter (mm ² /AWG)	Battery wire diameter (mm ² /AWG)	Load wire diameter (mm ² /AWG)
MT1050-EU/RS485	10A	10A	2.5/13	2.5/13	2.5/13
MT1550-EU	15A	10A	4/11	4/11	2.5/13
MT2075/2010	20A	20A	5/10	5/10	5/10
MT3075/3010	30A	30A	6/9	6/9	6/9
MT4010/4015	40A	30A	10/8	10/8	6/9

 The indicated cable/wire sizes are for reference only. If longer runs between the PV array and the controller or between the controller and the battery are required, then larger capacity cables must be used to reduce voltage drop and improve system performance.

5.4 Connection

We strongly recommend connecting a fuse directly to the battery terminal to protect from any short circuit in the battery circuit. PV-modules generate current whenever light shines on them. The generated current is directly proportional to the light intensity. Even low levels of light, will deliver the PV-Modules no load, full voltage. It is thus utterly advisable to protect PV-modules from any incident light during installation; Never touch uninsulated cables (ends), only use electric insulated tools, and make sure that the wire cross section is adequate for the PV module operating currents. Connections must always be conducted in the sequence as described below

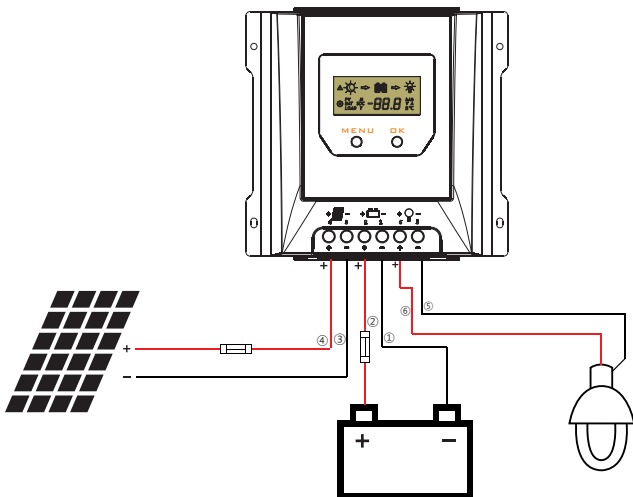



WARNING: The PV-module/array can produce open-circuit voltages in excess of 100 Vdc when exposed to sunlight. Pay highest attention to this fact.



WARNING: Risk of explosion! In case the battery's positive and negative terminals or leads get ever in touch, i.e. short-circuited, a fire or explosion hazard might get triggered. Always pay maximum when handling batteries and related circuits.



CAUTION: 1. When the controller is not connected with the external temperature sensor, the internal temperature of the battery is 25 °C.

2.If a power inverter is used the system, directly connect the inverter to the battery. Do not connect it to the controller's load terminals.

1st step: Connect the battery

Connect the battery cables observing the correct polarity to the center pair of terminals (make sure you identify the battery marking/symbol on the controller casing!) of the PV charge controller. Pay great attention to polarity. Never, ever invert the plus+ and minus- poles). Should your system be nominal 12 Vdc, make sure the battery voltage is between the 5.0 and 15.0 Vdc voltage range; for 24 Vdc nominal voltage, the battery voltage should be within the 20.0 to 31.0 Vdc range; for 48 Vdc nominal voltage, the battery voltage should be within the 40.0 to 62.0Vdc. If the polarity is correct, the LCD on the controller will begin to display those.

2nd step: Connect the solar module

When connecting the PV-Module make sure to cover it from incident sun light. Double check the PV-Module will not exceed the maximum permissible input current of the Charge Controller (please refer to the section Technical Data). Connect the solar module connection cable to the correct polarity of the left pair of terminals on the solar charge controller (with the solar module symbol).

3rd step: Connect loads

Connect the load cable with the correct polarity of the right-hand side pair of terminals on the solar charge controller (with the lamp symbol). To avoid the presence of any tension on the cable/wires, please connect these first to the load before connecting them to the charge controller.

4th step: Final work

Tighten all cables connected to the controller and remove all the remains around the controller (leaving a void of minimum 15 cm).

5.5 Grounding

Be aware that the negative terminals of the controller are interconnected and therefore bear the same electrical potential. If any grounding is required, always do this on the negative wires/terminals.









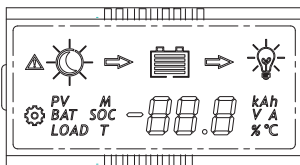









CAUTION: For common-negative system, such as motorhome, it is recommended to use a common-negative controller; but if in a common-negative system, some common-positive equipment is used, and the positive pole is grounded, the controller may get damaged.

6, Operation

6.1 LCD Display



6.1.1 Status Description

Item	Icon	Status
PV array	 	Daytime, not charging
	 	Daytime, charging
		Night
	<i>PV</i>	PV voltage, current and ampere hours
	<i>PV T</i>	The total charge ampere hours of the solar panel
Battery		Battery capacity
	 <i>BAT</i>	Battery voltage(Set Charging target voltage for lithium battery)
	<i>BAT</i>	Battery current
	<i>BAT SOC</i>	Battery state of charge(in %)
	 <i>25 °C</i>	Temperature(Clear Bluetooth Device Password)
	 <i>BAT T GEL</i>	Battery type(Programmable)
Load	 <i>LOAD</i>	Load voltage(Set low voltage protection voltage)
	<i>LOAD</i>	Load current and ampere hours
	<i>LOAD T</i>	The total discharge ampere hours of the load
	 <i>LOAD M</i>	Load mode(Programmable)
	  	The load is on
	 	The load is off
Fault		Fault indication, see 6.1.4

 PV array charge ampere hours and load ampere hours are off after power failure.



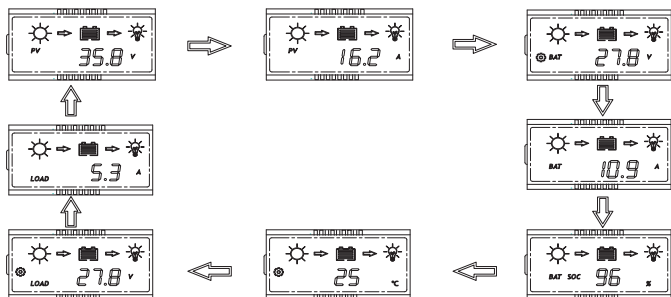

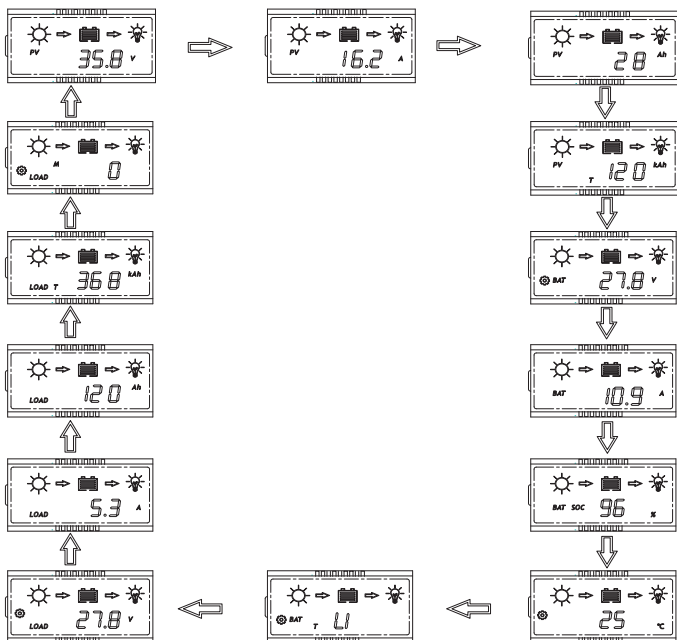

6.1.2 The interface automatically cycles in the displayed sequence



6.1.3 Press OK to browse the interface



6.1.4 Fault indication

Status	Icon	Description
Short circuit	 E1	Load off, fault icon display, load icon flashes, the LCD screen displays E1
Over current	 E2	Load off, fault icon display, load icon flashes, the LCD screen displays E2
Low voltage	 E3	Battery level shows empty, fault icon display, battery frame flashes, the LCD screen displays E3
Over voltage	 E4	Battery level shows full, fault icon display, battery flashes, the LCD screen displays E4
Over temperature	 E5	The charge and discharge are off, fault icon display, icon °C flashing, the LCD screen displays E5
Controller does not correctly identify system voltage	 E5	Controller does not correctly identify system voltage.

6.2 Key function





Mode	Operating
Browse interface	Short press OK
Static display	Press the MENU and OK key at the same time for 1s, the LCD screen will lock the interface. Press the MENU and OK key again for 1s, the LCD interface will unlock and start scrolling.
Setting parameter	Press the MENU key for 1s to enter the setting mode when the icon  appears on the display interface, and exit automatically after 30s
Load On/Off	When the controller is working in street lamp mode, press the MENU key for 3s to turn on the load, press the MENU key again or 1min later the load will be turned off.

6.3 USB interface

MT-EU series have two USB interfaces, maximum output of single USB is 5V 1.5A, maximum output of two USB is 5V 2A, for charging mobile phones and other smart devices.

The USB stops output only when the controller is in low voltage protection.

6.4 Parameters setting

When the icon  appears in the display interface, it means that the parameters can be set. Press the **MENU** key for 1s, then icon  flashes, press **OK** to change the parameter.

6.4.1 Charging target voltage(Lithium)

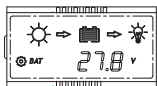

If the battery type is set to lithium battery, the LCD display interface is shown in the left figure. Long press the **MENU** key for 1 second, the icon  flashes to set the charging target voltage of lithium battery.

Setting range of Charging target voltage:

12V:10.0 ~ 17.0V (default: 14.4V)

12/24V:10.0 ~ 32.0V (default: 14.4V)

12/24/36/48V:10.0 ~ 64.0v (default: 29.4V)

The controller automatically calculates the charging recovery voltage according to the charging target voltage. The charging recovery voltage is approximate $0.97 * \text{Charging target voltage}$.

If the battery type is not lithium battery, there is no icon in the current interface.

6.4.2 Low voltage protection and recovery voltage

When the LCD shows as displayed at left, press the **MENU** key for 1s, the icon  flashes, now you can set the controller's low voltage protection voltage.

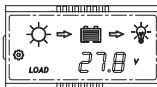

1.If the battery is set to lithium battery, the low voltage protection voltage setting range is as follow:

12V:9.0 ~ 16.0V (default: 10.6V)

12/24V:9.0 ~ 30.0V (default: 10.6V)

12/24/36/48V: 9.0 ~ 60.0V (default: 21.0V)

The controller automatically calculates the low voltage recovery voltage according to the low voltage protection voltage. The low voltage recovery voltage is approximate $1.11 * \text{low voltage protection voltage}$.

2. If the battery is not lithium battery, the low voltage protection mode of the controller is divided into battery voltage control and capacity control.

①Battery voltage control setting range :

10.8~11.8V/21.6~23.6V/32.4~35.4V/43.2~47.2V

(default:11.2V/22.4V/33.6V/44.8V).

The default low voltage recovery voltage of the controller is

0.8/1.6/2.4/3.2V higher than the low voltage protection voltage. If you want to reduce the low voltage recovery voltage, please reduce the low voltage protection voltage first.

② Battery capacity control

Display	Low voltage protection range	Low voltage reconnect
S-1	11.0~11.6V/22.0~23.2V/33.0~34.8V/44.0~46.4V	12.4/24.8/37.2/49.6V
S-2	11.1~11.7V/22.2~23.4V/33.3~35.1V/44.4~46.8V	12.5/25.0/37.5/50.0V
S-3	11.2~11.8V/22.4~23.6V/33.6~35.4V/44.8~47.2V	12.6/25.2/37.8/50.4V
S-4	11.4~11.9V/22.8~23.8V/34.2~35.7V/45.6~47.6V	12.7/25.4/38.1/50.8V
S-5	11.6~12.0V/23.2~24.0V/34.8~36.0V/46.4~48.0V	12.8/25.6/38.4/51.2V

6.4.3 Clear Bluetooth Device Password

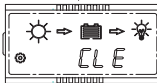
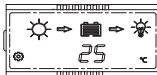

When the LCD shows as displayed at left, press the **MENU** key for 1s, the icon  flashes, you can press **OK** to clear the Bluetooth device password set by the mobile app.

 For device passwords, please refer to Bluetooth APP instructions.

6.4.4 Battery type

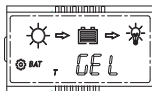

When the LCD shows as displayed at left, press the **MENU** key for 1s, the icon  flashes, you can set the battery type.

Display	Battery type
GEL	GEL(Default)
L19	Liquid
AG-	AGM
LI	Lithium

1.Charging Voltage Parameters(Liquid, GEL, AGM)

When choosing Liquid, GEL or AGM for battery type, the parameters of boost, equalization and float charge voltage can be set by mobile phone APP, RS485 or Wechat APP. The range of parameters is as follows.

The following voltage parameters are 25°C/12V system parameters, 24/48V displayed values are multiplied by a factor of 2/4.

Charging stage	Boost	Equalization	Float
Charging Voltage Range	14.0~14.8V	14.0~15.0V	13.0~14.5V
Default charging voltage	14.5V	14.8V	13.7V

2.Charging Voltage Parameters(Lithium)

When choosing lithium battery type, the Charging target and recovery voltage of lithium battery can be set by pressing the key (see 6.3.1 setting selection for details), mobile phone APP, RS485 or Wechat APP.

Charging target voltage setting range:

12V: 10.0~17.0V (default:14.4V)

12/24V: 10.0~32.0V (default:14.4V)

24/48V: 20.0~64.0V (default:29.4V)

Charging recovery voltage setting range:

12V: 9.2~16.8V (default:14.0V)

12/24V: 9.2~31.8V (default:14.0)

24/48V: 18.2~63.8V (default:28.7)



Note:

(Overcharge Recovery Voltage+1.5V) ≥ Lithium Overcharge Protection Voltage ≥ (Overcharge Recovery Voltage+0.2V)



Warning: The required accuracy of BMS shall be at least 0.2V. If tolerance is larger than 0.2V, manufacturer will not assume any liability for any consequent system malfunction.

6.4.5 Load mode

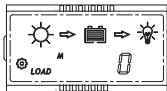

When the LCD shows as displayed at left, press the **MENU** key for 1s, the icon  flashes, you can set the load mode.

Display	Load mode
0	Always on Mode: The load output is always switched on.
1	Dusk to Dawn Mode: The load output is switched on between sunset and sunrise.
23456789	Evening Mode: The load output will be switched on for 2~9hours after sunset.
USE	Manual Mode: The load output can be switched on and off manually by pressing MENU shortly.

1.Always on Mode

When the controller is set to always On mode, no matter the charging or discharging state, the load is always powered on (except in when in protection state).

2. Street lamp Function

When the load is set to Dusk to Dawn or Evening mode, the Day/Night threshold voltage and the Day/Night delay time can be set by the mobile phone APP, RS485 or Wechat APP, and the load can be turned on or off by the test function during the day charging process.

2.1 Day/Night threshold voltage

The controller recognizes day and night based on the solar array open circuit voltage.

This day/night threshold voltage can be modified according to local light conditions and the solar array used.

Day/Night threshold setting range: 3.0~10.0V(Lithium, default: 8.0V)

Day/Night threshold setting range: 3.0~10/6.0~20/12~40V(Liquid/Gel/AGM, Default: 8/16/32V)

2.2 Day/Night delay time

In the evening, when the solar array open circuit voltage reaches the setting day/night detect voltage, you can adjust the day/night delay time to make the load turn on a little bit later.

Day/Night delay time setting range: 0~30min(Default: 0min)

2.3 Test Function

When the controller is working in Dusk to Dawn or Evening mode, press the **MENU** key for 3s to turn on the load. Press the **MENU** key again or the load turns off automatically after 1 minute.

If the controller is operating in always on mode, the test function does not work.

3. User-definde Mode

①If the load mode is selected "USE", then you can switch on and off the load output manually by pressing **MENU** shortly.

②The default switching state of the load in manual mode can be changed by mobile APP, RS485 or Wechat APP. At the same time, the output to the load can be turned on or off.













1.If the controller turns off the load due to low voltage protection, overcurrent protection, short-circuit protection or over temperature protection, the load will turn on automatically when the controller recovers from protection state.

2.Please note: Pushing the MENU button can still activate the function of the key, even during of the above four kinds protection states.

7, Troubleshooting, Protections and maintenance

7.1 Troubleshooting

Faults	Reason	Troubleshooting
  E1	Short Circuit	①Clear short circuit fault ②Restart the controller or press the key to restore the load output
  E2	Over Current	①Reduce electrical equipment; ②Restart the controller or press the key to clear the fault load and restore the output
  E3	Battery voltage is too low	Load will be reconnected when battery is recharged
  E4	Battery voltage is too high	Check if other sources overcharge the battery. If not, controller is damaged.
 °C E5	Over temperature	After the temperature decreases, the controller will work normally
	Battery voltage is abnormal at start-up	Charge or discharge the battery so that the battery voltage is within the normal operating range (5.0~15.0V or 20~31V or 40~62V)
Battery can't be charged during daytime	PV panel fault or reverse connection	Check panels and connection wires

7.2 Protection

Protection	Description
PV Over Current	The controller will limit charging power to the rated level. Over-sized PV array will not be able to operate at the maximum power point.
PV Short Circuit	When PV short circuit occurs, the controller will stop charging. Remove it to resume normal operation. When the PV doesn't charge, the controller will not be damaged if short-circuit just happened in the PV array. Warning: It is forbidden to short-circuit the PV array during charging. Otherwise, the controller may be damaged.
PV Reverse Polarity	Fully protection against PV reverse polarity, no damage to the controller. Correct the connection to resume normal operation.
Battery Reverse Polarity	Fully protection against battery reverse polarity, no damage to the controller. Correct the connection to resume normal operation.
Battery Over voltage	Should there are other energy sources to charge the battery, when the battery voltage exceeds 15.8 / 31.3/62.3V(Overcharge protection voltage of lithium battery equals target voltage plus 0.2V), the controller will stop charging to protect the battery from overcharging damage.
Battery Over discharge	When the battery voltage drops to the low voltage disconnect setting, the controller will stop discharging to protect the battery from over discharging
Load Over Current Protection	If the load current exceeds the maximum load current rating 1.25 times, the controller will automatically cut off the output. If the load reconnects the output automatically 10 times, it needs to be cleared by pressing the test key, restarting the controller or switching from Night to the Day.
Load Short Circuit Protection	When the load output of the controller is short circuited, the controller will automatically cut off the output. If the load reconnects the output automatically 10 times, it needs to be cleared by pressing the test key, restarting the controller or switching from Night to the Day.
Over Temperature Protection	The controller detects the internal temperature through internal sensor, when the temperature exceeds the setting value, the charging current will decrease. The controller stops working when the internal temperature exceeds 75°C and resumes work when the internal temperature is below 65°C.
Damaged Remote Temperature Sensor	When the external temperature sensor is damaged or not connected, the controller will charge at 25 °C by default to prevent overcharge from damaging the battery.

7.3 Maintenance

For best system performance, the following inspections and maintenance tasks are recommended to be carried out for at least two times a year.

- Make sure no block on air-flow around the controller. Clear up any dirt and fragments on radiator.
- Check all the naked wires to make sure insulation is not damaged. Repair or replace some wires if necessary.
- Tighten all terminal screws to the indicated torque; Inspect for loose, broken, or burnt cable/wire connections.
- Check and confirm that LCD is consistent with required. Pay attention to any troubleshooting or error indication. Take corrective action if necessary.
- Make sure all system components are effectively and tightly connected to ground.
- Check all terminals for any corrosion signs, damaged insulation, increased temperature .
- Check for any dirt, nesting insects and any corrosion signs. Implement corrections actions as early as possible.

WARNING: Risk of electric shock!



Make sure that all the power is turned off before above operations, and then follow the corresponding inspections and operations.

8, Technical Data

	Item	MT1050-EU	MT1050-RS485	MT1550-EU
Battery Parameters	System Voltage	12V		
	Max Charging Current	10A		15A
	MPPT Charging Voltage	before boost or equalization charging stage		
	Boost Voltage	14.5V@25°C		
	Equalization Voltage	14.8V@25°C(Liquid ,AGM)		
	Float Voltage	13.7V@25°C		
	Low Volt. Disconnect	10.8~11.8V, SOC1~5(default:11.2V)		
	Overcharge Protect	15.5V		
	Temp. Compensation	-4.17mV/K per cell (Boost, Equalization), -3.33mV/K per cell (Float)		
	Charging target voltage	10.0~17.0V(Programmable, default: 14.4V)		
	Low voltage disconnect	9.0~15.0V(Programmable, default: 10.6V)		
	Battery Type	Gel, AGM, Liquid, Lithium (default: Gel)		
	Max volt on Bat. termina	20V		
Panel Parameters	Max volt on PV terminal	45V		35V
	Max input power	130W		200W
	Day/Night threshold	8.0V		
	MPPT tracking range	(Battery Voltage + 1.0V) ~Voc*0.9 ^{*2}		
Load	Output Current	10A		
	USB interface	5V, 2A	/	5V, 2A
	Load mode	Always on, Street lamp, User-defind Mode		
System Parameters	Max tracking efficiency	>99.9%		
	Max charge conversion	97.5%		
	Dimensions	189 * 96 * 53mm		
	Weight	420g		
	Self consumption	0.2W		
	Communication	/	RS485	/
	Grounding	Common Negative		
	Power terminals	8AWG(10mm ²)		
	Ambient temperature	-20 ~ +55°C		
	Storage temperature	-25 ~ +80°C		
	Ambient humidity	0 ~ 100%RH		
Protection degree	IP32			
Max Altitude	4000m			

*1. Maximum solar panel voltage at minimum ambient operating temperature.

*2. Voc: PV-Module open circuit voltage.

	Item	Mt2010	MT3010	MT2075	MT3075
Battery Parameters	Max Charging Current	20A	30A	20A	30A
	System Voltage	12V/24V automatical recognition			
	MPPT Charging Voltage	before boost or equalization charging stage			
	Boost Voltage	14.0~14.8V/28.0~29.6V @25°C (default:14.5/29V)			
	Equalization Voltage	14.0~15.0V/28.0~30.0V @25°C (default:14.8/29.6V)			
	Float Voltage	13.0~14.5V/26.0~29.0V @25°C (default:13.7/27.4V)			
	Low voltage disconnect	10.8~11.8V/21.6~23.6V, SOC1~5(default: 11.2/22.4V)			
	Low voltage reconnect	11.4~12.8V/22.8~25.6V (default: 12.0/24.0V)			
	Overcharge Protect	15.8/31.3V			
	Temp. Compensation	-4.17mV/K per cell (Boost, Equalization), -3.33mV/K per cell (Float)			
	Charging target voltage	10.0~32.0V(Lithium, default: 14.4V)			
	Charging recovery voltage	9.2~31.8V(Lithium, default: 14.0V)			
	Low voltage disconnect	9.0~30.0V(Lithium, default: 10.6V)			
	Low voltage reconnect	9.6~31.0V(Lithium, default: 12.0V)			
	Battery Type	Gel, AGM, Liquid, Lithium (default: Gel)			
Max volt on Bat. Terminal	35V				
Panel Parameters	Max volt on PV terminal	95V		55V	
	Max input power	260/520W	390/780W	260/520W	390/780W
	Day/Night threshold	3.0~20.0V (default: 8.0/16.0V)			
	Day/Night delay time	0~30min (default: 0min)			
	MPPT tracking range	(Battery Voltage + 1.0V) ~Voc*0.9 ²			
Load	Output Current	20A	30A	20A	30A
	Load mode	Always on, Street lamp, User-defind Mode			
System Parameters	Max tracking efficiency	>99.9%			
	Max charge conversion	98.0%			
	Dimensions(mm)	189 * 182 * 64	189 * 255 * 63	189 * 182 * 58	189 * 182 * 64
	Weight	1.3Kg	1.5Kg	1Kg	1.3Kg
	Self consumption	≤8mA(12V), ≤12mA(24V)			
	Communication	RS485(RJ11 interface)			
	Optional	IOT,Cyber-BT(Internal / External)			
	Grounding	Common Negative			
	Power terminals	6AWG(16mm ²)			
	Ambient temperature	-20 ~ +55°C			
	Storage temperature	-25 ~ +80°C			
	Ambient humidity	0 ~ 100%RH			
	Protection degree	IP32			
Max Altitude	4000m				

	Item	Mt4010
Battery Parameters	Max Charging Current	40A
	System Voltage	12V/24V automatical recognition
	MPPT Charging Voltage	before boost or equalization charging stage
	Boost Voltage	14.0~14.8V/28.0~29.6V @25°C (default:14.5/29V)
	Equalization Voltage	14.0~15.0V/28.0~30.0V @25°C (default:14.8/29.6V)
	Float Voltage	13.0~14.5V/26.0~29.0V @25°C (default:13.7/27.4V)
	Low voltage disconnect	10.8~11.8V/21.6~23.6V, SOC1~5(default: 11.2/22.4V)
	Low voltage reconnect	11.4~12.8V/22.8~25.6V (default: 12.0/24.0V)
	Overcharge Protect	15.8/31.3V
	Temp. Compensation	-4.17mV/K per cell (Boost, Equalization), -3.33mV/K per cell (Float)
	Charging target voltage	10.0~32.0V(Lithium, default: 14.4V)
	Charging recovery voltage	9.2~31.8V(Lithium, default: 14.0V)
	Low voltage disconnect	9.0~30.0V(Lithium, default: 10.6V)
	Low voltage reconnect	9.6~31.0V(Lithium, default: 12.0V)
	Battery Type	Gel, AGM, Liquid, Lithium (default: Gel)
Max volt on Bat. Terminal	35V	
Panel Parameters	Max volt on PV terminal	95V
	Max input power	520/1040W
	Day/Night threshold	3.0~20.0V (default: 8.0/16.0V)
	Day/Night delay time	0~30min(default: 0min)
	MPPT tracking range	(Battery Voltage + 1.0V) ~ Voc*0.9 ²
Load	Output Current	30A
	Load mode	Always on, Street lamp, User-defind Mode
System Parameters	Max tracking efficiency	>99.9%
	Max charge conversion	98.0%
	Dimensions	189 * 255 * 69mm
	Weight	2Kg
	Self consumption	≤8mA(12V),≤12mA(24V)
	Communication	RS485(RJ11 interface)
	Optional	IOT,Cyber-BT(Internal / External)
	Grounding	Common Negative
	Power terminals	6AWG(16mm ²)
	Ambient temperature	-20 ~ +55°C
	Storage temperature	-25 ~ +80°C
	Ambient humidity	0 ~ 100%RH
Protection degree	IP32	
Max Altitude	4000m	

	Item	Mt4015
Battery Parameters	Max Charging Current	40A
	System Voltage	24V/48V automatical recognition
	MPPT Charging Voltage	before boost or equalization charging stage
	Boost Voltage	28.0~29.6V/56.0~59.2V @25°C (default:29.0/58.0V)
	Equalization Voltage	28.0~30.0V/56.0~60.0V @25°C (default:29.6/59.2V)
	Float Voltage	26.0~29.0V /52.0~58.0V@25°C (default:27.4/54.8V)
	Low voltage disconnect	21.6~23.6V/43.2~47.2V,SOC1~5(default: 22.4/44.8V)
	Low voltage reconnect	22.8~25.6V/45.6~51.2V (default: 24.0/48.0V)
	Overcharge Protect	31.3/62.3V
	Temp. Compensation	-4.17mV/K per cell (Boost, Equalization), -3.33mV/K per cell (Float)
	Charging target voltage	20.0~64.0V(Lithium, default: 29.4V)
	Charging recovery voltage	18.2~63.8V(Lithium, default: 28.7V)
	Low voltage disconnect	18.0~60.0V(Lithium, default: 21.0V)
	Low voltage reconnect	18.6~62.0V(Lithium, default: 22.4V)
	Battery Type	Gel, AGM, Liquid, Lithium (default: Gel)
Max volt on Bat. Terminal	65V	
Panel Parameters	Max volt on PV terminal	150V
	Max input power	1000/2000W
	Day/Night threshold	6.0~40.0V (default: 16.0/32.0V)
	Day/Night delay time	0~30min(default: 0min)
	MPPT tracking range	(Battery Voltage + 1.0V) ~Voc*0.9 ²
Load	Output Current	30A
	Load mode	Always on, Street lamp, User-defind Mode
System Parameters	Max tracking efficiency	>99.9%
	Max charge conversion	98.7%
	Dimensions	189 * 255 * 89mm
	Weight	2.5Kg
	Self consumption	≤8mA
	Communication	RS485(RJ11 interface)
	Optional	IOT,Cyber-BT(Internal / External)
	Grounding	Common Negative
	Power terminals	6AWG(16mm ²)
	Ambient temperature	-20 ~ +55°C
	Storage temperature	-25 ~ +80°C
	Ambient humidity	0 ~ 100%RH
	Protection degree	IP32
Max Altitude	4000m	

9. Conversion Efficiency Curves

Test conditions: Illumination intensity: 1000W/m² Temperature: 25°C

Model: MT1050-EU/MT1050-RS485

12V Conversion Efficiency Curves
Solar Module MPP Voltage 18V/36V

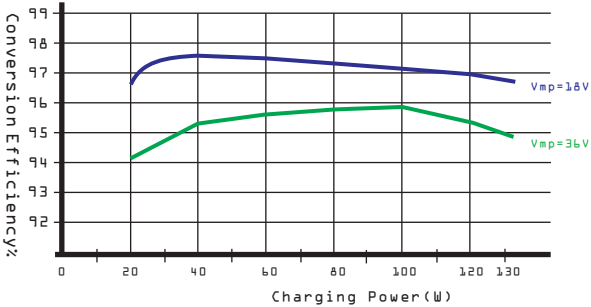

Model: MT1550-EU

12V Conversion Efficiency Curves
Solar Module MPP Voltage 18V

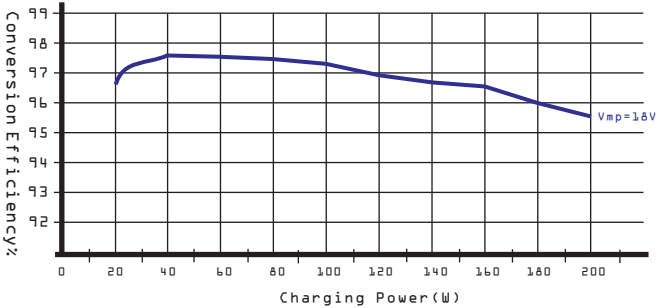

12V Conversion Efficiency Curves
Solar Module MPP Voltage 18V/36V

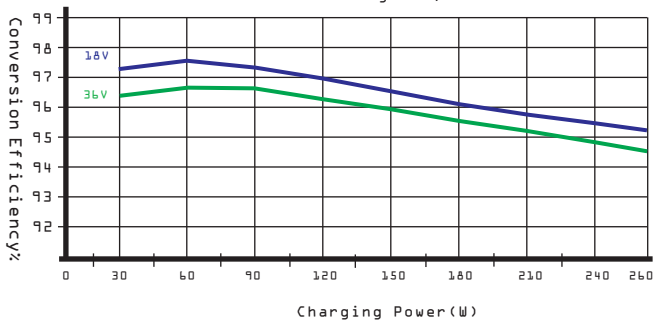

24V Conversion Efficiency Curves
Solar Module MPP Voltage 36V/54V/72V

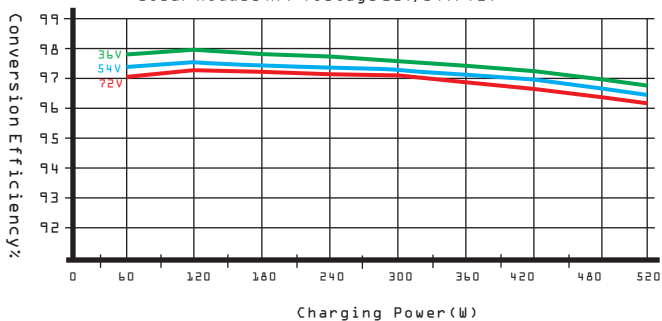

12V Conversion Efficiency Curves
Solar Module MPP Voltage 18V/36V

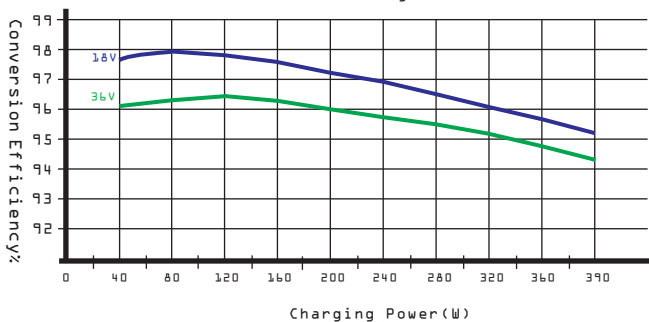

24V Conversion Efficiency Curves
Solar Module MPP Voltage 36V/54V/72V

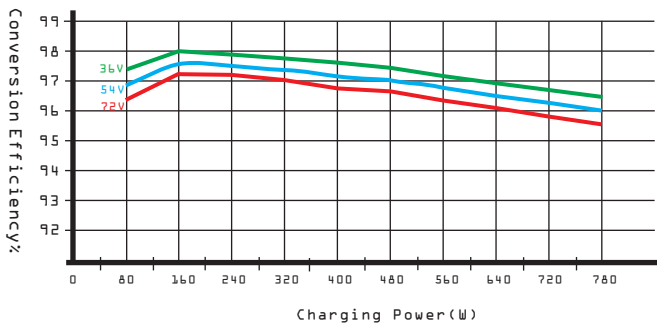

Model: MT4010

12V Conversion Efficiency Curves
Solar Module MPP Voltage 18V/36V

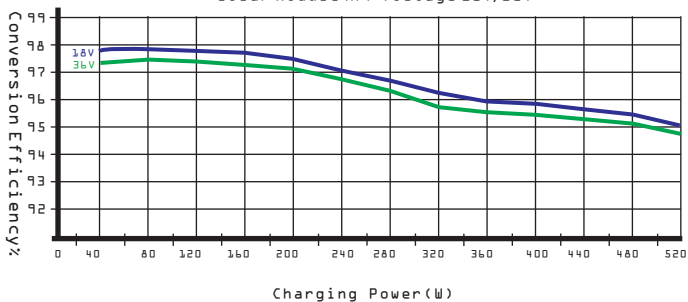

24V Conversion Efficiency Curves
Solar Module MPP Voltage 36V/54V/72V

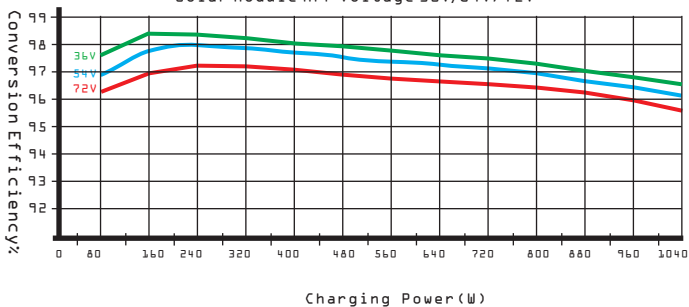

Model: MT4015

24V Conversion Efficiency Curves
Solar Module MPP Voltage 36V/54V/72V

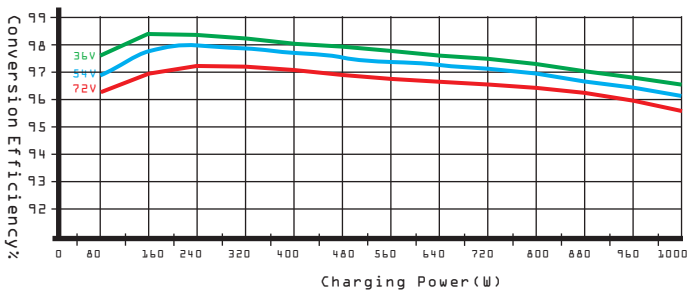

48V Conversion Efficiency Curves
Solar Module MPP Voltage 72V/90V

